

LED Displays

Order code	Manufacturer code	Description
57-0120	SA56-11HWA	0.56" LED DISPLAY ANODE RED (RC)
57-0122	SA56-11EWA	0.56" LED DISPLAY ANODE HE RED (RC)
57-0124	SA56-11SRWA	COMMON ANODE SUPER RED 0.56IN (RC)
57-0125	SC56-11HWA	0.56" LED DISPLAY CATHODE RED (RC)
57-0127	SC56-11EWA	0.56" DISPLAY CATHODE HE RED (RC)
57-0129	SC56-11SRWA	COMMON CATHODE SUPER RED .56IN (RC)
57-0170	SA56-11GWA	SA56-11GWA 14.2MM GREEN DISPLAY (RC)
57-0172	SC56-11GWA	SC56-11GWA 14.2MM GREEN DISPLAY (RC)
57-0174	SA56-21GWA	SA56-21GWA 14.2MM GREEN DISPLAY
57-0176	SC56-21GWA	SC56-21GWA 14.2MM GREEN DISPLAY (RC)

LED Displays	Page 1 of 7
The enclosed information is believed to be correct, Information may change 'without notice' due to product improvement. Users should ensure that the product is suitable for their use. E. & O. E.	Revision A 04/07/2003

Kingbright®

14mm (0.56INCH) SINGLE DIGIT NUMERIC DISPLAYS

SA56-11	SC56-11
SA56-21	SC56-21
FA56-11	FC56-11

Features

- 0.56 INCH DIGIT HEIGHT.
- LOW CURRENT OPERATION.
- EXCELLENT CHARACTER APPEARANCE.
- UNIVERSAL 1. OVERFLOW AVAILABLE.
- EASY MOUNTING ON P.C. BOARDS OR SOCKETS.
- I.C. COMPATIBLE.
- CATEGORIZED FOR LUMINOUS INTENSITY, YELLOW AND GREEN CATEGORIZED FOR COLOR.
- MECHANICALLY RUGGED.
- STANDARD : GRAY FACE, WHITE SEGMENT.

Description

The Red source color device are made with Gallium Arsenide Phosphide Red Light Emitting Diode.

The Bright Red source color devices are made with Gallium Phosphide Red Light Emitting Diode.

The Green source color devices are made with Gallium Phosphide Green Light Emitting Diode.

The High Efficiency Red source color devices are made with Gallium Arsenide Phosphide on Gallium Phosphide Orange Light Emitting Diode.

The Yellow source color devices are made with Gallium Arsenide Phosphide on Gallium Phosphide Yellow Light Emitting Diode.

The Super Bright Red source color devices are made with Gallium Aluminum Arsenide Red Light Emitting Diode.

Package Dimensions & Internal Circuit Diagram

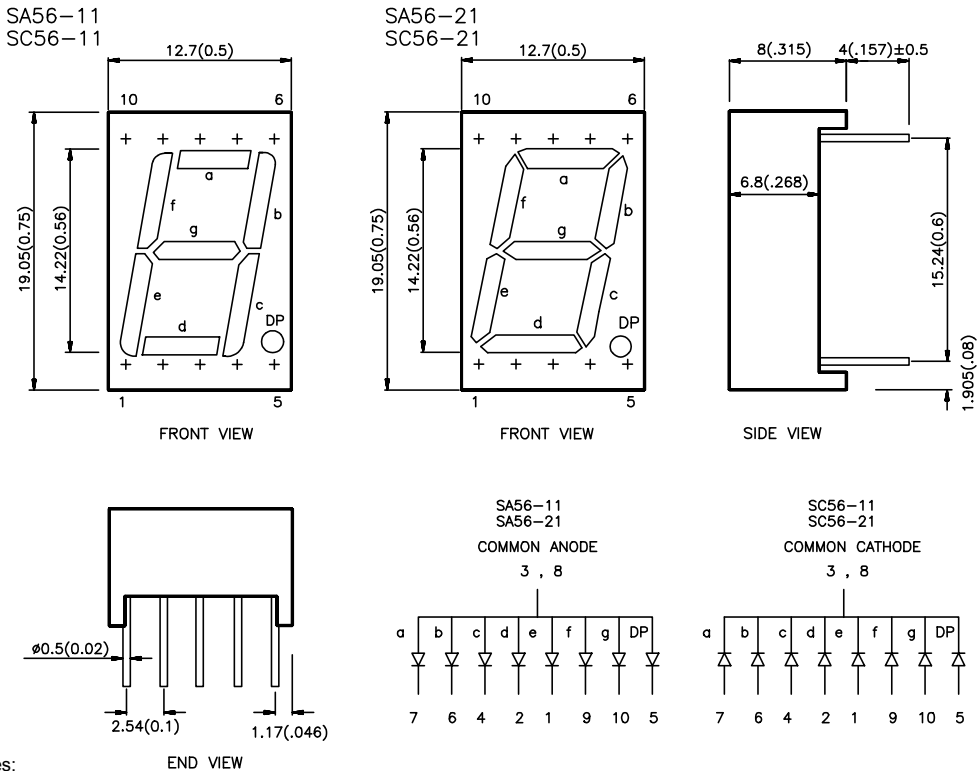

Package Dimensions & Internal Circuit Diagram

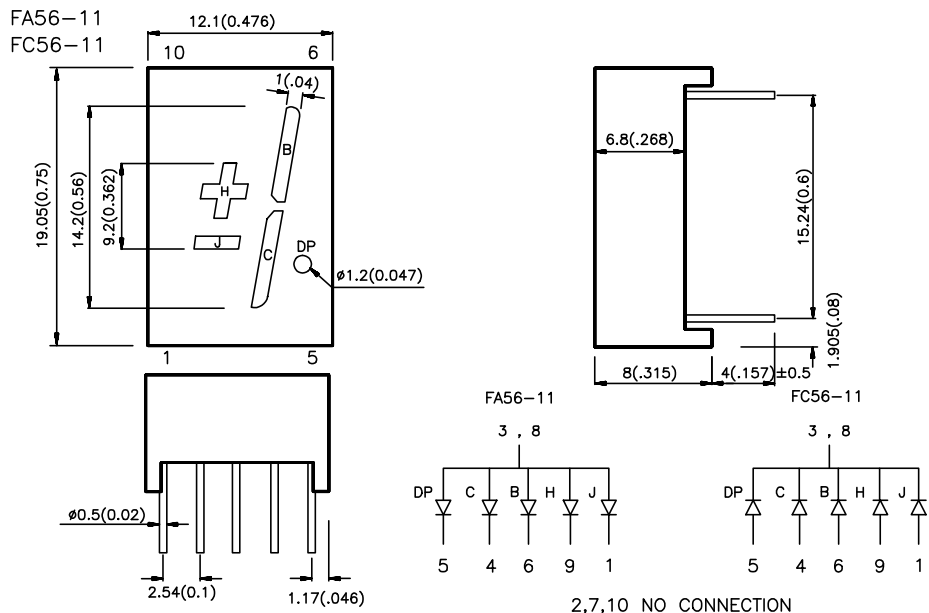

Selection Guide

Part No.	Dice	Iv (ucd) @ 10 mA		Description
		Min.	Max.	
SA56-11RWA SA56-21RWA FA56-11RWA	RED (GaAsP)	240	560	Common Anode, Rt. Hand Decimal
SC56-11RWA SC56-21RWA FC56-11RWA				Common Cathode, Rt. Hand Decimal
SA56-11HWA SA56-21HWA FA56-11HWA				BRIGHT RED (GaP)
SC56-11HWA SC56-21HWA FC56-11HWA	Common Cathode, Rt. Hand Decimal			
SA56-11EWA SA56-21EWA FA56-11EWA	HIGH EFFICIENCY RED (GaAsP/GaP)	2200	5600	
SC56-11EWA SC56-21EWA FC56-11EWA				Common Cathode, Rt. Hand Decimal
SA56-11GWA SA56-21GWA FA56-11GWA				GREEN (GaP)
SC56-11GWA SC56-21GWA FC56-11GWA	Common Cathode, Rt. Hand Decimal			
SA56-11YWA SA56-21YWA FA56-11YWA	YELLOW (GaAsP/GaP)	2200	5600	
SC56-11YWA SC56-21YWA FC56-11YWA				Common Cathode, Rt. Hand Decimal
SA56-11SRWA SA56-21SRWA FA56-11SRWA				SUPER BRIGHT RED (GaAlAs)
SC56-11SRWA SC56-21SRWA FC56-11SRWA	Common Cathode, Rt. Hand Decimal			

Electrical / Optical Characteristics at T_A=25°C

Symbol	Parameter	Device	Typ.	Max.	Units	Test Conditions
λ_{peak}	Peak Wavelength	Red Bright Red High Efficiency Red Green Yellow Super Bright Red	660 700 625 565 590 660		nm	IF=20mA
$\Delta\lambda_{1/2}$	Spectral Line Halfwidth	Red Bright Red High Efficiency Red Green Yellow Super Bright Red	20 45 45 30 35 20		nm	IF=20mA
C	Capacitance	Red Bright Red High Efficiency Red Green Yellow Super Bright Red	40 40 12 45 10 95		pF	VF=0V;f=1MHz
V _F	Forward Voltage	Red Bright Red High Efficiency Red Green Yellow Super Bright Red	1.7 2.0 2.0 2.2 2.1 1.85	2.1 2.5 2.5 2.5 2.5 2.5	V	IF=20mA
I _R	Reverse Current	All	10		uA	VR = 5V

Absolute Maximum Ratings at T_A=25°C

Parameter	Red	Bright Red	High Efficiency Red	Green	Yellow	Super Bright Red	Units
Power dissipation	120	120	105	105	105	100	mW
DC Forward Current	30	25	30	25	30	30	mA
Peak Forward Current [1]	150	150	150	150	150	150	mA
Reverse Voltage	5	5	5	5	5	5	V
Operating/Storage Temperature	-40 °C To +85 °C						
Lead Soldering Temperature [2]	260 °C For 5 Seconds						

Notes:
 1. 1/10 Duty Cycle, 0.1ms Pulse Width.
 2. 4mm below package base.

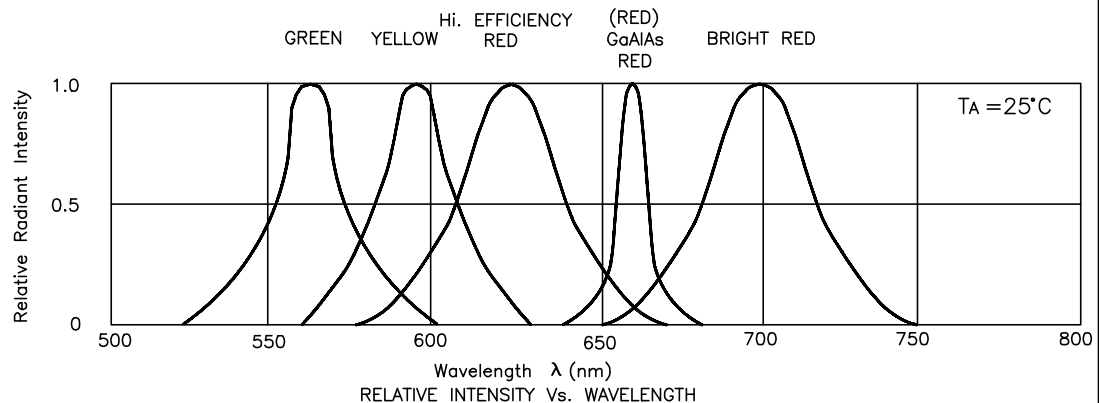

Red

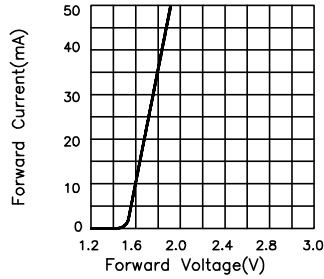

FORWARD CURRENT Vs. FORWARD VOLTAGE

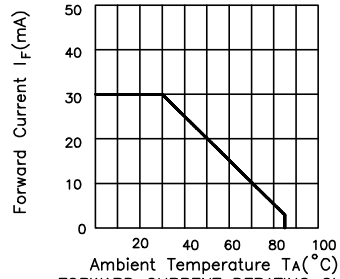

FORWARD CURRENT DERATING CURVE

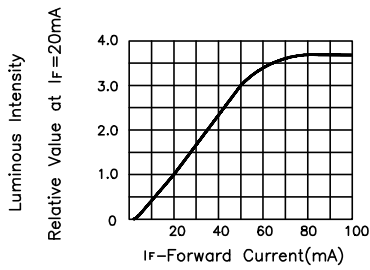

LUMINOUS INTENSITY Vs. FORWARD CURRENT

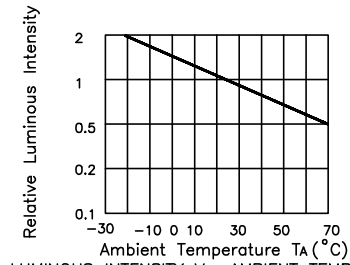

LUMINOUS INTENSITY Vs. AMBIENT TEMPERATURE

Bright Red

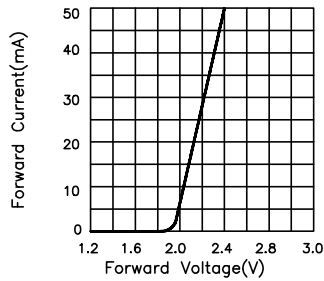

FORWARD CURRENT Vs. FORWARD VOLTAGE

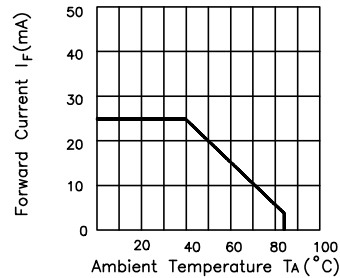

FORWARD CURRENT DERATING CURVE

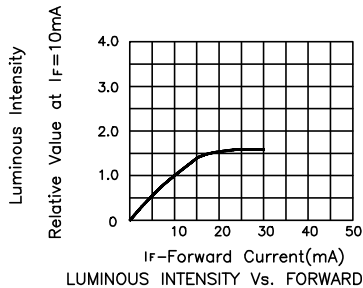

LUMINOUS INTENSITY Vs. FORWARD CURRENT

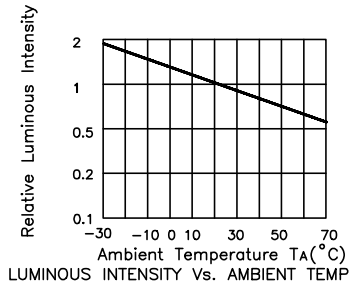

LUMINOUS INTENSITY Vs. AMBIENT TEMPERATURE

High Efficiency Red

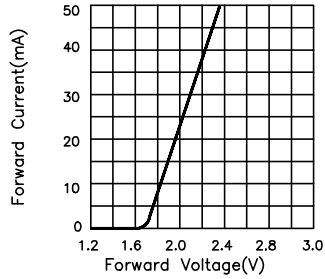

FORWARD CURRENT Vs. FORWARD VOLTAGE

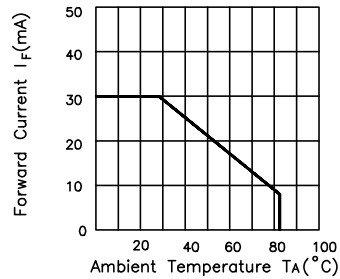

FORWARD CURRENT DERATING CURVE

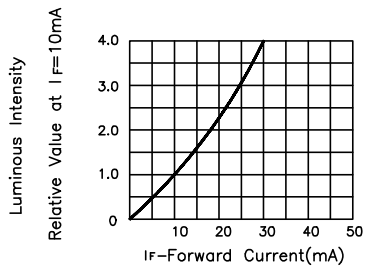

LUMINOUS INTENSITY Vs. FORWARD CURRENT

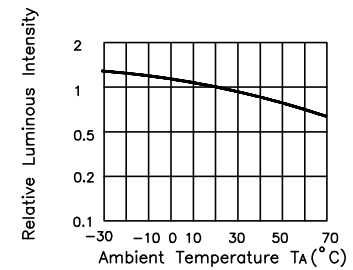

LUMINOUS INTENSITY Vs. AMBIENT TEMPERATURE

Green

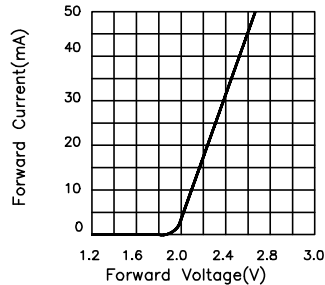

FORWARD CURRENT Vs. FORWARD VOLTAGE

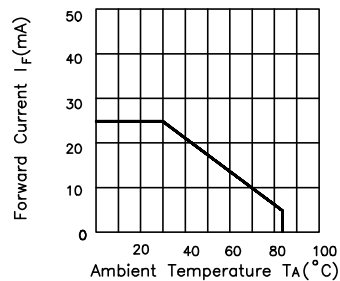

FORWARD CURRENT DERATING CURVE

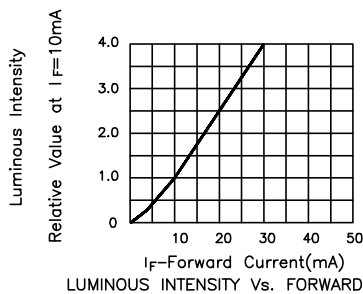

LUMINOUS INTENSITY Vs. FORWARD CURRENT

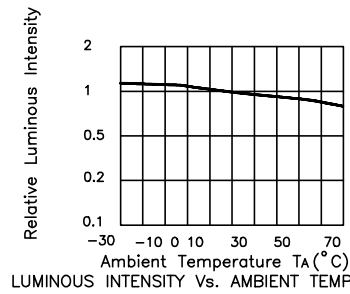

LUMINOUS INTENSITY Vs. AMBIENT TEMPERATURE

Yellow

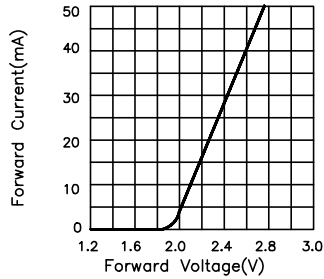

FORWARD CURRENT Vs. FORWARD VOLTAGE

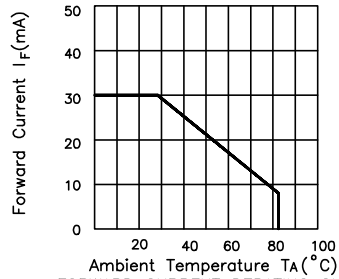

FORWARD CURRENT DERATING CURVE

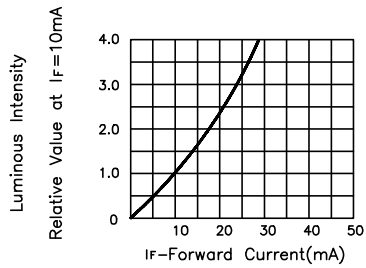

LUMINOUS INTENSITY Vs. FORWARD CURRENT

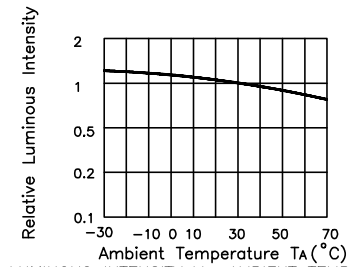

LUMINOUS INTENSITY Vs. AMBIENT TEMPERATURE

Super Bright Red

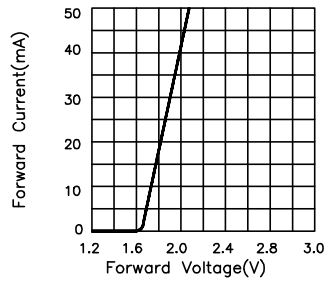

FORWARD CURRENT Vs. FORWARD VOLTAGE

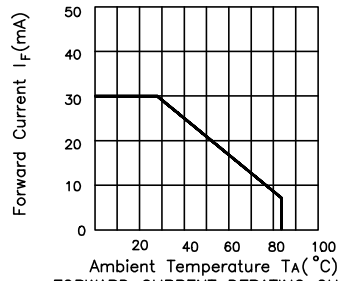

FORWARD CURRENT DERATING CURVE

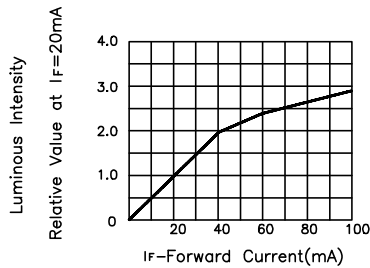

LUMINOUS INTENSITY Vs. FORWARD CURRENT

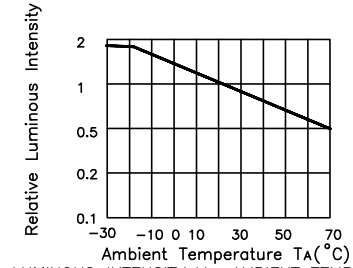

LUMINOUS INTENSITY Vs. AMBIENT TEMPERATURE